

- RJ 45 - Cat 5e / Cat 6 / Cat 6A
- RJ 45 - Kat 5e / Kat 6 / Kat 6A
- RJ 45 - Kar. 5e / Kar. 6 / Kar. 6A

- RJ 45 - Kat. 5e / Kat. 6 / Kat. 6A
- RJ 45 接口 - 超 5 类 / 6 类 / 增强型 6 类双股线
- RJ 45 - 5e kat. / 6. kat. / 6A kat.

UTP / UTP نمط / UTP 双股线 	Cat 5e / Kat 5e / Kar. 5e / Kat. 5e / 超 5 类双股线 / 5e kat.	5 700 58 - 5 710 58 - 5 723 03 5 728 03 - 5 734 29 - 5 736 29	5 723 15/56 - 5 728 15/56 5 734 75 - 5 736 75	
	Cat 6 / Kat 6 / Kar. 6 / Kat. 6 / 6 类双股线 / 6 kat.	5 700 57 - 5 710 57 - 5 723 02/54/55 5 728 02/54/55 - 5 734 28 - 5 736 28	5 700 59 - 5 710 59 - 5 723 14/53 5 728 14/53 - 5 734 74 - 5 736 74	5 723 24 - 5 728 24
	Cat 6A / Kat 6A / Kar. 6A / Kat. 6A / 增强型 6 类双股线 / 6A kat.	5 723 49/58/59 - 5 728 49/58/59/64/65	5 723 57 - 5 728 57	
FTP / FTP نمط / FTP 双股线 	Cat 5e / Kat 5e / Kar. 5e / Kat. 5e / 超 5 类双股线 / 5e kat.	5 723 04 - 5 728 04 - 5 734 30 - 5 736 30		
	Cat 6 / Kat 6 / Kar. 6 / Kat. 6 / 6 类双股线 / 6 kat.	5 723 22 - 5 728 22	5 723 16 - 5 728 16 5 734 76 - 5 736 76	
STP / STP نمط / STP 双股线 	Cat 6 / Kat 6 / Kar. 6 / Kat. 6 / 6 类双股线 / 6 kat.	5 723 23 - 5 728 23 - 5 734 34 - 5 736 34	5 723 17 - 5 728 17 5 734 77 - 5 736 77	
	Cat 6A / Kat 6A / Kar. 6A / Kat. 6A / 增强型 6 类双股线 / 6A kat.	5 723 06/51/52 - 5 728 06/51/52 5 734 32 - 5 737 32	5 723 50 - 5 728 50	

- Câblage (AWG 22.....26)
- Bekabeling (AWG 22.....26)
- Cabling (AWG 22 to 26)
- Verdrahtung (AWG 22 bis 26)
- Cableado (AWG 22.....26)
- Cablagem (AWG 22-26)
- Καλωδίωση (AWG 22.....26)
- Προκλάδα καλωδίων (AWG 22.....26)
- Kablolama (AWG 22.....26)
- (AWG 22.....26) ربط الأسلاك
- 布线 (AWG 22.....26)
- Cablaggio (AWG 22.....26)
- Okablowanie (AWG 22.....26)
- Kábelezés (AWG 22.....26)

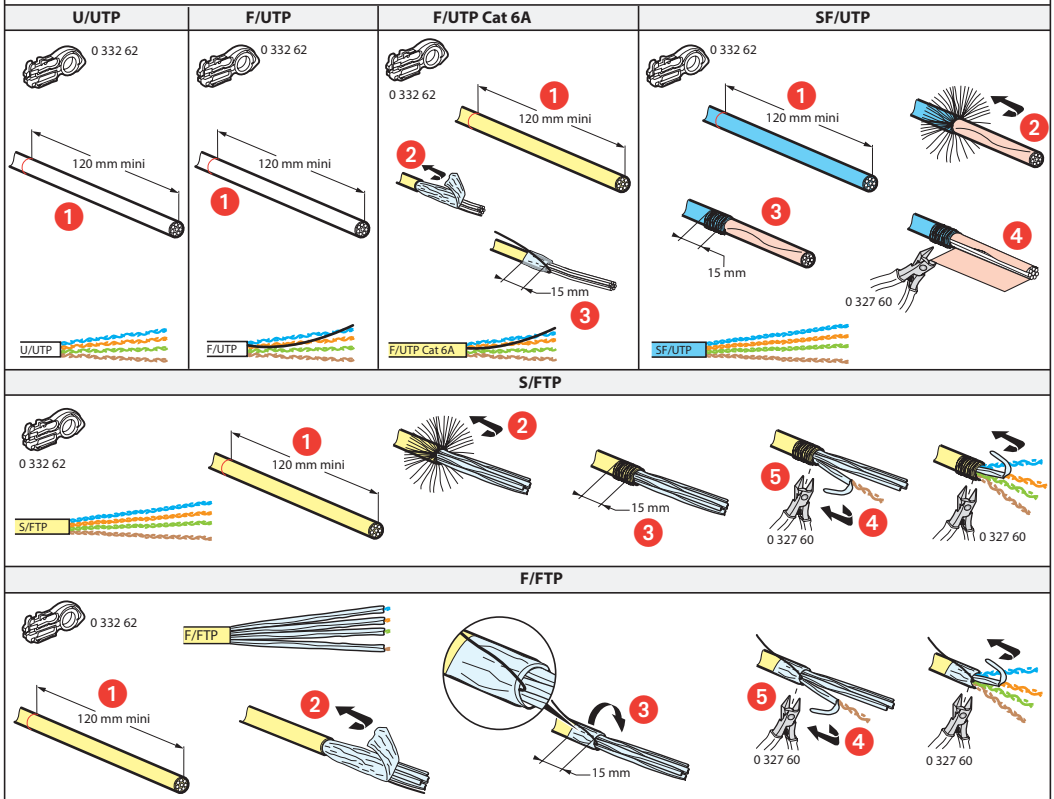

U/FTP



0 332 62

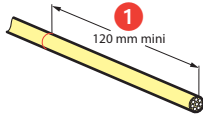

1

120 mm mini

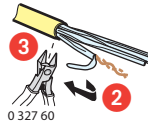

3

0 327 60



0 327 60

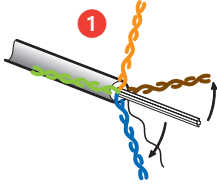

1

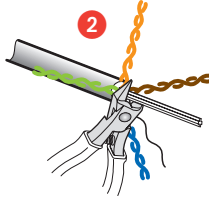

2

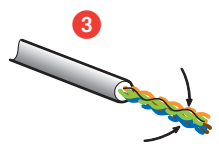

3

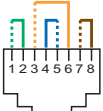

EIA568 A / EIA 568 A 标准

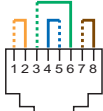

EIA568 B / EIA 568 B 标准

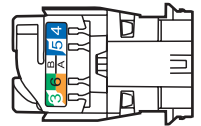
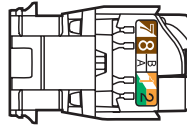

13 mm  
مم 13  
13 毫米

Cat 5e / Kat 5e / Кат. 5е /  
Kat. 5e / 超5类双股线 / 5e kat.  
Cat 6 / Kat 6 / Кат. 6 /  
Kat. 6 / 6类双股线 / 6 kat.  
Cat 6A / Kat 6A / Кат. 6A /  
Kat. 6A / 增强型6类双股线 /  
6A kat.

≤ 13 mm max.  
≤ 13 mm max.  
≤ max. 13 mm  
≤ 13 mm μέγ.  
≤ 13 mm máx.  
≤ 13 MM макс

≤ En çok 13 mm.  
≥ مم حد أقصى 13  
≤ 最大 13 毫米  
≤ maks. 13 mm  
≤ Maximum 13 mm

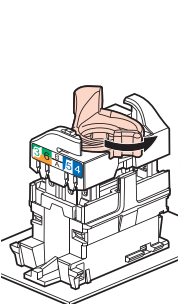
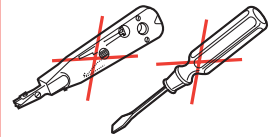

1

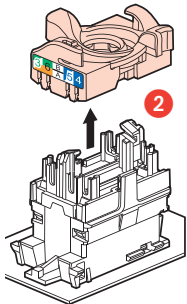

2

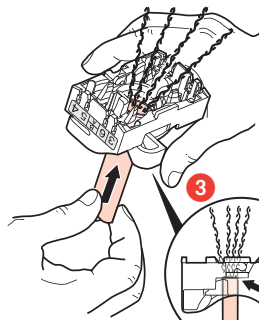

3

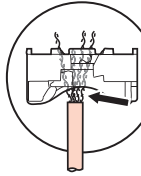

NO  
NEEN  
NEIN  
OXI  
Неверно  
FAUX  
NIE  
HELYTELEN

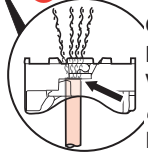

OK  
Верно  
VRAI  
موافق  
HELYES

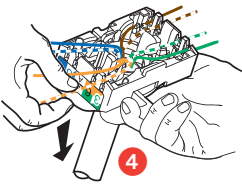

4

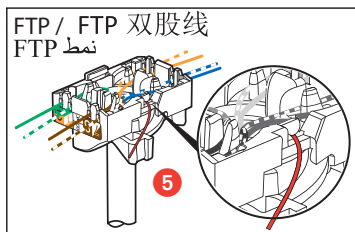

5

FTP / FTP 双股线  
FTP نمط

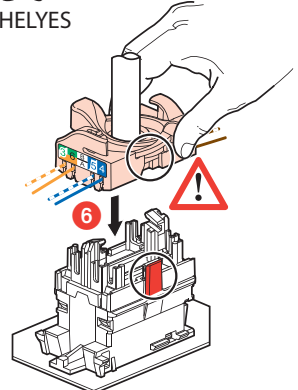

6

7 OK / **Верно** / VRAI /  
موافق HELYES

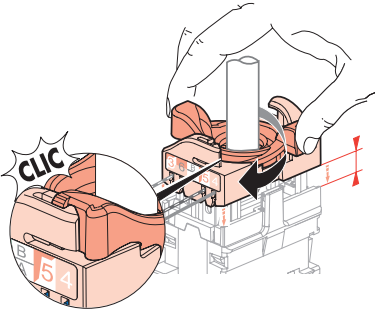

KLIK / KLIICK /  
KAIK / KLIK /  
"كليك" / 点击 /  
KATT

7 NO / NEEN / NEIN / **OXI** / **Неверно** /  
**FAUX** / ❌ / NIE / HELYTELEN ❌

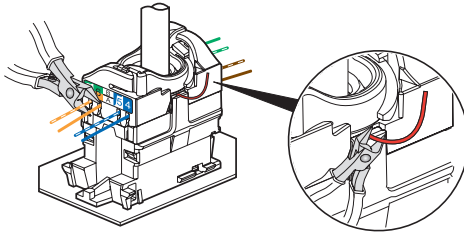
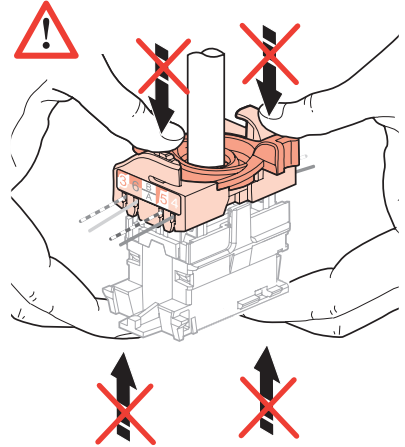

STP / STP **نمط** STP 双股线

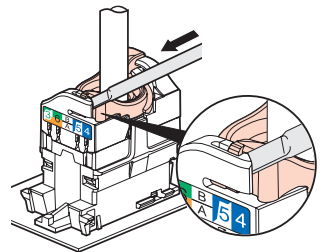
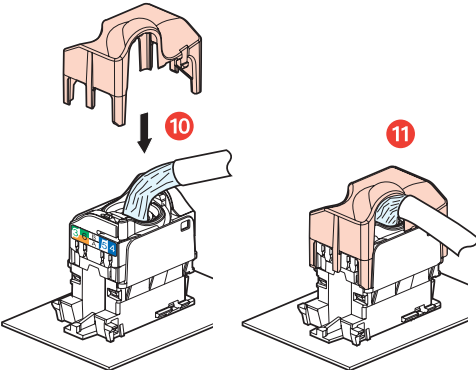

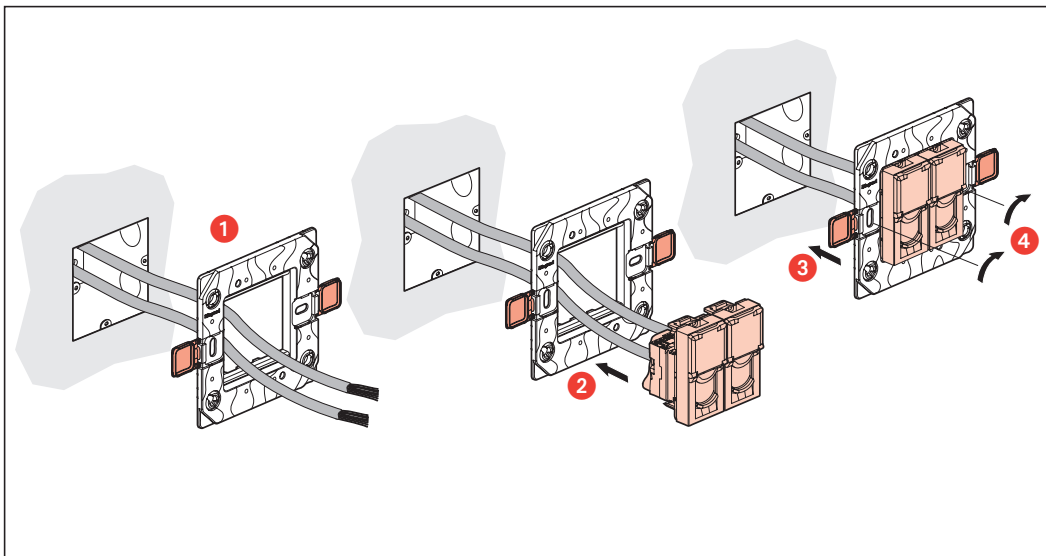

#### ⚠ **Consignes de sécurité**

Avant toute intervention, couper le courant.  
Respecter strictement les conditions d'installation et d'utilisation.

(FR LU BE)

#### ⚠ **Меры предосторожности**

Отключить питание перед проведением любых ремонтных работ.  
Строго соблюдайте требования к условиям монтажа и эксплуатации.

(RU)

#### ⚠ **Veiligheidsinstructies**

Sluit de stroom af voordat u aan de slag gaat.  
Neem zorgvuldig de installatie- en gebruikvoorwaarden in acht.

(NL BE)

#### ⚠ **Güvenlik talimatları**

Her türlü müdahale öncesinde, elektrik akımını kesiniz.  
Kurulum ve kullanım koşullarına kesinlikle uyunuz.

(TR CY)

#### ⚠ **Safety instructions**

Make sure the power supply is disconnected before any intervention.  
Strictly comply with instructions for installation and use.

(GB IE)

⚠ إرشادات الأمان:

"اقطع التيار الكهربائي، قبل أي تدخل. تقيّد تقيداً تاماً بشروط التثبيت والاستخدام."

#### ⚠ **Sicherheitshinweise**

Vor jeglichem Eingriff die Spannungsfreiheit sicherstellen.  
Einbau- und Gebrauchsanleitungen sind genau zu beachten.

(DE)

#### ⚠ **安全警示**

在进行任何作业前，请切断电源。  
请严格遵守相关安装和使用条件的要求。

#### ⚠ **Consignas de seguridad**

Antes de realizar cualquier intervención, cortar la corriente eléctrica.  
Respetar estrictamente las condiciones de instalación y uso.

(ES)

#### ⚠ **Istruzioni di sicurezza**

Prima di effettuare qualsiasi intervento, togliere la corrente.  
Rispettare scrupolosamente le condizioni di installazione e d'uso.

(IT CH)

#### ⚠ **Instruções de segurança**

Antes de qualquer intervenção, cortar a corrente.  
Respeitar estritamente as condições de instalação e de utilização.

(PT)

#### ⚠ **Zalecenia bezpieczeństwa**

Przed przystąpieniem do prac należy odłączyć zasilanie.  
Ścisłe przestrzegać warunków instalacji i użytkowania.

(PL)

#### ⚠ **Οδηγίες ασφαλείας**

Πριν από κάθε παρέμβαση, διακόψτε την παροχή ρεύματος.  
Τηρήστε αυστηρά τις συνθήκες εγκατάστασης και χρήσης.

(GR CY)

#### ⚠ **Biztonsági előírások**

Bármilyen beavatkozás előtt szakítsa meg az áramellátást.  
A beszerelési és használati előírásokat szigorúan be kell tartani.

(HU)